

FOOTSTEPS

No.15 JUNE 1993

SOIL EROSION

Soil and water conservation and the community

by Will Critchley and Olivia Graham

SOIL EROSION – the removal of good soil by wind or water – is a growing problem world-wide. As the world population increases, more pressure is put on land to produce food, fuel and building materials. Trees are removed to grow more crops. Often land is no longer left to rest between cropping. With the removal of trees and forests, there is a direct effect on water supply. Less rainwater is able to soak into the soil and, in some places, wells and springs dry up. As good soil is removed through soil erosion, yields are reduced.

Soil conservation generally involves a lot of work with few immediately obvious benefits. It may take several years of effective soil conservation measures before the benefits begin to be appreciated. Soil conservation is rarely a priority for poor farmers struggling to produce enough food for this year, with little time or energy to be concerned about yields several years in the future. However, without the conservation of the farmer's most precious resource – the soil – the future is very bleak.

Soil conservation is rarely straightforward. Without a stable system of land ownership, few farmers are prepared to put effort into

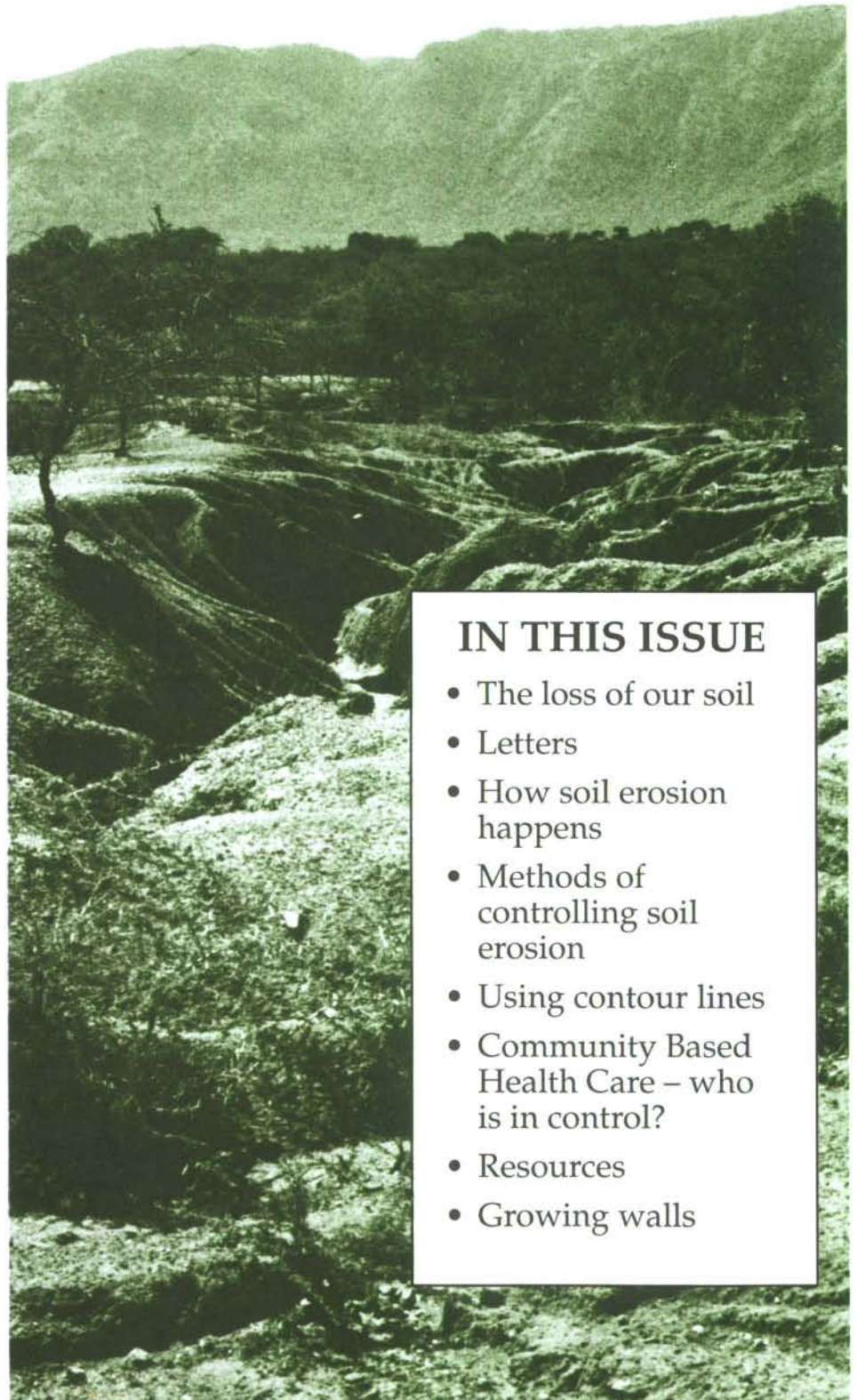

IN THIS ISSUE

- The loss of our soil
- Letters
- How soil erosion happens
- Methods of controlling soil erosion
- Using contour lines
- Community Based Health Care – who is in control?
- Resources
- Growing walls

FOOTSTEPS

Footsteps is a quarterly paper linking health and development workers worldwide. Tear Fund, publisher of *Footsteps*, hopes that it will provide the stimulus of new ideas and enthusiasm. It is a way of encouraging Christians of all nations as they work together towards creating wholeness in our communities.

Footsteps is free of charge to individuals working to promote health and development. It is available in English, French and Spanish. Donations are welcomed.

Readers are invited to contribute views, articles, letters and photos.

Editor: Isabel Carter

83 Market Place, South Cave, Brough, N Humberside, HU15 2AS, UK.

Editorial Committee:

Jerry Adams, Dr Ann Ashworth, Mike Carter, Jennie Collins, Jennifer Evans, Richard Franceys, George Goddard, Sue Hanley, Suleiman Jakonda, Dr Ted Lankester, Sandra Michie, Nigel Poole, Jim Rowland, José Smith, John Wibberley

Illustrator: Rod Mill

Design: Wingfinger Graphics, Leeds

Translation:

Alison Coz, Totoya Dew, Helen Machin, Nicole Mauriange

Mailing List:

Write, giving brief details of your work and stating preferred language, to: *Footsteps* Mailing List, Tear Fund, 100 Church Road, Teddington, Middlesex, TW11 8QE, UK. Tel: 081 977 9144

Articles and illustrations from *Footsteps* may be adapted for use in training materials encouraging health and rural development provided the materials are distributed free of charge and that credit is given to *Footsteps*, Tear Fund.

Published by Tear Fund. A company limited by guarantee. Regd in England No 994339. Regd Charity No 265464.

TEAR FUND 
CHRISTIAN CONCERN IN A WORLD OF NEED

preserving the land for future generations. Land inheritance systems may need consideration. Holdings are often fragmented as land is passed on, making it very difficult to encourage conservation.

Concern about soil erosion is nothing new. Various programmes set up by colonial administrations in Africa earlier this century have had a poor record of success. Many lessons in erosion control have been learnt since then. Mistakes have been made. Successes have been achieved. Though the methods developed may be different for each culture, climate and country, there are some general principles that apply everywhere.

ORGANISATION

■ Participation

Participation is the key to success. Farmers are the main part of the solution, not part of the problem. In some countries, unpopular colonial rules and regulations were often used to provide forced labour for large scale erosion control programmes. After independence, governments in these countries have found it difficult to motivate people in soil conservation. Any project must win the respect and co-operation of the local people. They must be involved from the very beginning in all aspects of planning, training and action through to monitoring and evaluation.

■ Motivation and training

A person with plenty of knowledge and skills, but no motivation, achieves little. On the other hand, a motivated person will easily develop his or her own skills and knowledge. Local people need to be helped to

understand how land becomes eroded and how to improve land management. Once motivated, appropriate skills need to be put in the hands of the people themselves, not just a team of extension workers.

■ Use existing groups

An existing group (eg: church group, farmers' co-operative, women's self-help group) is almost always easier to work with than one which has to be specially formed.

What are other groups and organisations – both government and non-government – doing in your area or nearby? Work together with them whenever possible, to avoid confusion.

■ Life of the project

The life of a project should not be so short-lived that it has no chance to become truly effective. Effective soil conservation develops over many years. Projects should always plan for the eventual withdrawal of outside support.

■ Monitoring and evaluation

Adequate monitoring and evaluation systems need to be included in every project in order to collect data for analysing the costs and benefits of various techniques. Improvement of soil productivity is a slow process. Keep records and measure your success.

A project should be willing and able to alter its work plans in response to the experience with on-going monitoring and to people's priorities. Flexibility is not necessarily a weakness, but may be a strength!

TECHNICAL ISSUES

■ Choose appropriate systems

Has anyone studied the local conservation systems? Could they be adapted or improved? Build on what people already know and practise. Suitable systems survive with minimum support from outside.

- Are the systems you are planning appropriate?
- Do they use local resources?
- Are they cheap to implement?
- Will they be easily maintained?
- Have they been tested locally?

Soil conservation is rarely a priority for farmers struggling to produce enough food for this year.



The loss of our soil...

SOIL EROSION IS LIKE THEFT. Some theft happens slowly over a long period of time – a little is stolen each time. You don't notice what's happening until one day you realise how much has gone. Other theft is sudden, perhaps violent – you see it happening, and suddenly everything has gone.

With soil erosion, a slow steady flow of water or wind on a gentle slope can lift and move the small particles of soil evenly over the surface. This is called sheet erosion. It is not easy to see it happening until a lot of soil has already gone and you are left with the stones and gravel on the surface.

Over an uneven, sloping surface, water will collect in small channels called rills. The water collects and moves faster cutting deeper rills, and carrying away soil. The rills also collect together forming gullies, carrying great quantities of water and soil. Rill and gully erosion can happen very suddenly. After just a single

storm, the farmer may look with despair at the damage – small rills can suddenly develop into deep gullies.

Soil is not the only thing stolen. Precious water has also been lost. Perhaps because the soil was not covered by crops or trees, water has not had time to soak into the soil. Instead it has run over the surface to be lost from the farm. After a heavy rain storm, the farmer may dig down in the soil to find only the top few centimetres wet. Below that, it is completely dry.

There are other signs of water loss, too. Springs and wells may dry up. The ground water reserves are not being refilled. The streams and rivers are dry for most of the year. Further down the river valley, the opposite may be happening. There is flooding due to the sudden flow of water coming down the gullies and streams.

Too little water in one place and too much in another – all because the soil is no longer acting as an effective store for water.

Mike Carter

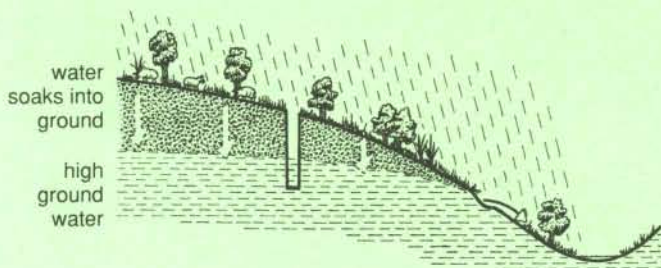

With good tree and crop cover, rain water soaks into the ground. The ground water rises so that wells and springs have plenty of water.

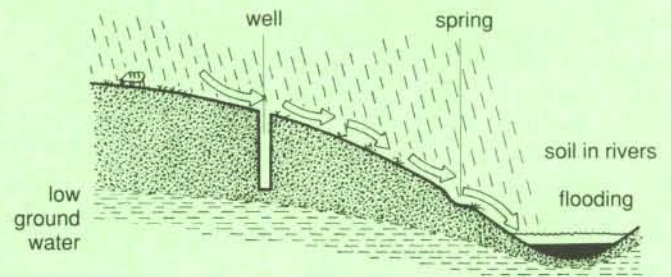

When trees or crops do not cover the soil, rain water runs over the surface, carrying soil with it. Wells and springs dry up.

Think carefully before any kind of mechanisation is introduced.

Special planning is needed to ensure that the project is reaching the poorest.

■ Ensure rapid benefits

Farmers want success now, not in ten years' time. Does the technique improve productivity or make yields more reliable? Give emphasis to water conservation as well as to soil conservation. The benefits of soil conservation may not be clear for several years after the work is done, but the benefits of water conservation can often be seen in the next crop.

■ Use incentives with care

For many years there has been a debate about the use of incentives in development work. It is not easy to generalise. Incentives can be useful in some soil conservation activities, particularly since there are so few

rapid benefits. Food for work or cash payment are generally best avoided. Tools for work may be a better choice.

■ Land use management

Conserving soil and water is only the starting point. A village committee is needed to take responsibility for land-use management; to plan grazing of land; to control gullies; to plan fuelwood supply; to plan communal waterways and the health of springs and wells, etc.

Without the conservation of the farmer's most precious resource – the soil – the future is very bleak.

This article was adapted from the introduction to the book Looking After Our Land, reviewed on page 14. Will Critchley works for the Centre for Development Cooperation Services, Amsterdam and has considerable experience of conservation and farming systems in Africa.





We enjoyed working with them and would encourage others to include children in their development work because...

- they are easy to talk to
- they are very fast workers, once given clear instructions
- they are careful in carrying out tasks they have been given.

Each member's efforts are important, and the contribution of children in development, however small, should be appreciated.

Titus Ayome
CRS – Madi/W Nile Diocese
Arua, Uganda

Tapeworm eggs

AS SO MANY BEFORE ME, I would like to congratulate you on an excellent, very helpful and, above all, 'human' publication! May your inkwell never run dry!

I was interested to read the comments on composting toilets in the September issue, as I share this interest. A major disadvantage of these toilets is, I believe, that the heat of the composting process kills off all germs, eggs, etc, except for those of the tapeworm (after one year's

composting). As these are then 'planted' in the soil, I have heard that their presence makes the fertiliser unsuitable for use on plants designed for human consumption. I would welcome comments from both yourselves and readers on their own experience in this area.

Duncan Levinsohn, Solbacha L9
573 97 Tranas, Sweden.

Editor...

Richard Franceys agrees, saying that tapeworm eggs can lie dormant and revitalise after a 3-6 year period.

Spanish request

CONGRATULATIONS on *Paso a Paso*. We work in five rural areas of Argentina with integrated projects combining literacy, home gardens, radio stations, social development and community development. Do you or any of your readers have material in Spanish for our radio stations? We would very much appreciate useful material which we could broadcast.

Jose Benito Bongarra
Centros Comunitarios Rurales Evangelicos
Tinogasta 5850
(1408) Buenos Aires
Argentina

More help from children

I HAVE READ WITH INTEREST in *Footsteps No 12* about involving children in development work. I, too, think it is a good and important thing to consider. I would like to share with you what we have done on our programme with children.

Christian Rural Service is a programme of the Church of Uganda, helping people to improve their well-being. In most cases we have been concentrating on working with adults, but neglecting children. This year I have tried to involve children aged 5-12 years. We were raising eucalyptus seedlings for our afforestation programme. A group of twelve children filled over 5,000 pots in two days.



FROM THE EDITOR

IT IS SADLY TRUE that in many parts of the world our parents can remember a very different environment from that of today. Deserts have grown. Fertile land has become poor. People are fighting to overcome these problems in many different ways. Soil erosion has become such a widespread problem that most countries now have government programmes to control erosion, programmes that add to the efforts of the farmers themselves.

Will Critchley and Olivia Graham provide some tried and tested guidelines for soil conservation

programmes. We include plenty of practical ideas for a wide variety of control methods. You may know of others you would like to share. We also have a very interesting follow-up to our issue on Partnership in Community Health Care.

The returned survey forms are providing a fascinating insight into what you think of *Footsteps* and how you are using your copies. Thank you for all the many encouragements you have given. Thanks too for all who have offered to contribute articles. This will help ensure that future issues will be as relevant and helpful as possible for our readers. The final results of the survey will not be known until the French and Spanish surveys are returned.

We hope to produce a Portuguese version of *Footsteps* soon. Please write in if you would like to order copies for your work.

Isabel Carter

How soil erosion happens

by Mike Carter

IMAGINE YOU NEED TO PUSH a loaded cart down a gentle slope. You first have to get the cart moving – this may need quite a hard push. Once the cart is moving, a steady, gentle push may keep it moving down the slope. Getting the cart moving in the first place takes a lot of effort – keeping it moving is easier.

This picture may help in understanding and controlling soil erosion. If soil particles are being eroded down a slope, something must first provide the push, firstly to **get** them moving and, secondly to **keep** them moving down the slope. With **wind** erosion, a strong gust of wind may lift soil off the ground – then a more gentle wind may be enough to keep it moving in the air for very long distances.

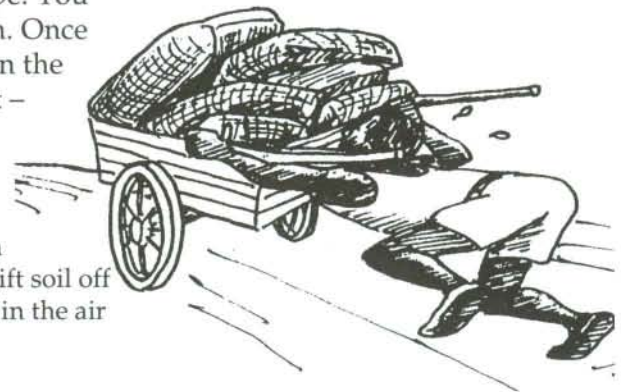

With erosion by **water**, the farmer faces two enemies...

Two enemies

Rain drop impact

The force of rain drops hitting the soil causes splashes that lift soil particles into the air. It also breaks up larger soil clumps into small ones, easier to move. Rain splash also makes the soil surface smooth, filling cracks with clay – water can then only penetrate such a surface slowly.

Run-off

Run-off is the water that moves over a sloping soil surface. This happens when the rain is falling faster than the rain can be soaked up into the soil. The faster run-off water moves, the more soil particles it can carry. How fast the water flows will depend, in turn, on how steep and how long the slope is.

Two solutions

Soil cover

Cover the soil as much as possible. Anything that can absorb the energy of raindrops will help – especially at the beginning of the rainy season, when storms are usually at their worst and the soil is often bare.

The cover needs to be close to the soil surface to protect it. For example, the leaves of tall trees give little protection. The leaves of a low lying shrub protect the soil surface well.

Barriers

Stop water moving down the slope **or** slow the water down so it cannot carry so much soil.

Anything that makes the soil more level, or that divides a slope into shorter lengths, will reduce run-off speed. Slower moving water causes less erosion – it also has more time to soak into the soil.

In areas with heavy storms, build strong barriers and create controlled waterways to channel excess water to safety.

Control methods

Cover methods

- Mulching
- Cover crops and green manures
- Inter-cropping and mixed cropping
- Early planting
- Crop residues
- Agroforestry
- Minimum cultivation



Barrier methods

- Contour grass strips
- Contour hedges and trees
- Contour ploughing
- Contour ridges and ditches
- Contour crop planting
- Contour trash lines
- Terracing

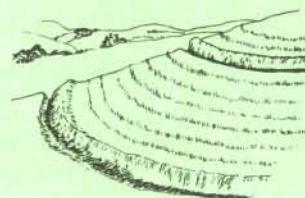

It is generally best to use several methods together. For example, mulching and grass strips used together with contour hedges.

Mike Carter is head of T-CORD at Bishop Burton Agricultural College, Beverley, North Humberside, UK, with experience of soil conservation programmes in Papua New Guinea and Kenya.

How to control soil erosion

1

COVER METHODS

These methods all protect the soil from the damaging effects of rain-drop impact. Most will also improve soil fertility.

Mulching

Bare soil between growing plants is covered with a layer of organic matter – such as straw, grasses, leaves and rice husks – anything readily available. Mulching also keeps the soil moist, reduces weeding, keeps the soil cool and adds organic matter. If termites are a problem, keep the mulch away from the stems of crops.

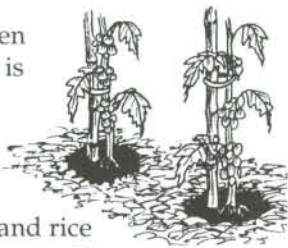

Cover crops and green manures

Cover crops are a kind of living mulch. They are plants – usually legumes – which are grown to cover the soil, also reducing weeds. Sometimes they are grown under fruit trees or taller, slow maturing crops. Sometimes they also produce food or fodder. Cowpeas, for example may be used both as a cover crop and a food crop.

Green manures – also usually legumes – are planted specially to improve soil fertility by returning



Cover crop of Mucuna.



fresh leafy material to the soil. They may be plants that are grown for 1–2 months between harvesting one crop and planting the next. The leaves may be cut and left on the surface of the soil as a mulch or the whole plant dug into the soil. Green manures may also be trees or hedges which may grow for many years in a cropping field from which green leaves are regularly cut for use as mulch (alley cropping).

Mixed cropping and inter-cropping

By growing a variety of crops – perhaps mixed together, in alternate rows, or sown at different times – the soil is better protected from rain splash.

Early planting

The period at the beginning of the rainy season when the soil is prepared for planting, is when the damage from rain splash is often worst. Sowing early will make the period when the soil is bare, as short as possible.

Crop residues

After harvest, unless the next crop is to be immediately replanted, it is a good idea to leave the stalks, stems and leaves of the crop just harvested, lying on the soil. They will give some cover protection until the next crop develops.

Agroforestry

Planting trees among agricultural crops helps to protect the soil from erosion, particularly after crops are harvested. The trees will give some protection from rain splash. Fruit, trees, legume trees for fodder or firewood and alley cropping all help reduce soil erosion.

Minimum cultivation

Each time the soil is dug or ploughed, it is exposed to erosion. In some soils



This Brazilian garden shows mixed cropping, agroforestry and grass strips.

it may be possible to sow crops without ploughing or digging, ideally among the crop residue from the previous crop. This is most likely to be possible in a loose soil with plenty of organic matter.

How to control soil erosion

2

BARRIER METHODS

Barrier methods all slow the flow of water down a slope. This greatly reduces the amount of soil which run-off water can carry away and conserves water. Any kind of barrier should work. To be effective any barrier must follow the contour lines.

Man-made terraces

In some countries terracing has been successfully practised for centuries – the Philippines, Peru and Nepal, for example. Well-built terraces are one of the most effective methods of controlling soil erosion, especially on steep slopes. However, terraces require skill and very hard work to build. Each terrace is levelled – first by levelling the sub-soil, then the top soil – and firm side supports are built, often of rock. Man-made terraces are



Well-established man-made terraces in Nepal. Note the heaps of manure on many of the terraces on the right of the photo.

unlikely to be an appropriate method in countries with no tradition of terrace building.

Contour ploughing

Whenever possible all land should be ploughed along the contour line – never up and down, since this simply encourages erosion. In some cultures this may be very difficult due to the pattern of land inheritance. For example the Luo people in Western Kenya inherit land in long strips running down to the river valleys, making contour ploughing extremely difficult. Soil conservation programmes may need to consider land redistribution schemes, or neighbouring farmers will have to work together.

Contour barriers

Almost any available material can be used to build barriers along the contours. Here are some examples:



Without secure land ownership, it is not easy to encourage soil conservation. After building grass strips and fences, this tenant farmer in Brazil was evicted by a local official. After several years of overgrazing, the grass terracing has still held.

old crop stalks and leaves, stones, grass strips, ridges and ditches strengthened by planting with grass or trees.

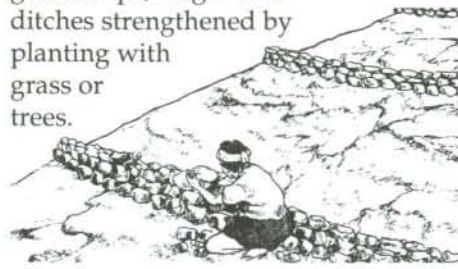

Natural terraces

David Stockley encourages the use of grass strips. He writes...

'Why do so much hard work (building terraces) when nature can do it for less? Let us make use of natural erosion. We planted grass along the contour lines. We used fibrous grasses with a dense root system such as Napier grass, Guatemala grass and Guinea grass. The strips of land in between were cultivated. As the soil is cultivated, nature moves the soil to form a natural terrace. The rainwater passes through the grass strip, depositing any soil carried behind the grass. In our experience in Bangladesh and Brazil, rains formed natural terraces within five years. Once well established, the grass barrier can be planted with banana, pineapple, coffee, fruit or firewood trees.'

Vetiver grass has been very effective in grass strips. It does not spread onto cultivated soil, it produces sterile seeds, has few pest problems and can

survive in a wide range of climates. For more information about Vetiver grass, write to:

Vetiver Information Network
World Bank,
1818 High Street NW,
Washington DC
20433,
USA



Medias lunas

This is a helpful system for reclaiming badly eroded land which has been used successfully in Bolivia. *Medias lunas* or crescent shaped depressions are built on sloping land. The crescent shapes are built at the end of the rainy season so the ridges made can be compacted well. The crescent collects the rainwater and soil. Trees – usually legumes – are planted when the next rainy season begins and protected by thorn branches from grazing animals. After 3 or 4 years each *media luna* will be covered with vegetation. Later, as the soil continues to improve, crops may be grown in the *medias lunas*.



Methods for sloping land

Gullies are common in areas without effective soil conservation methods. Once formed, they continue to grow. In a future issue we will look at how to control gullies, together with any other useful information readers may share on the subject of soil erosion.

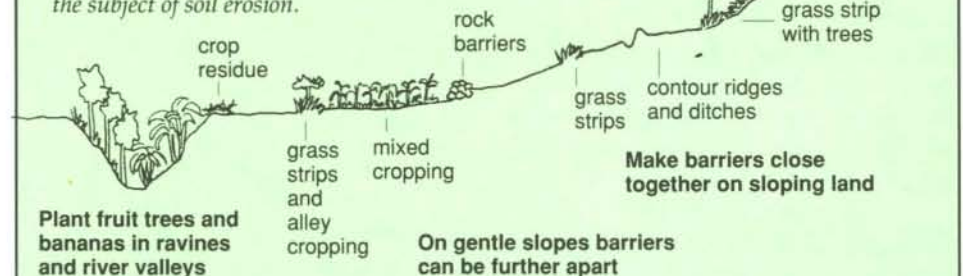

The A-Frame

MATERIALS NEEDED

- 2 poles about 2 metres long
- 1 shorter pole about 1 metre long
- some string
- a stone

STEP 1

Tie the poles very tightly together to make the shape of a letter A. Hang the stone from the top of the A-Frame, making sure the stone hangs below the cross bar.



STEP 2

Holding the frame upright, mark with two sticks exactly where the poles touch the ground. When the stone stops moving, mark where the string crosses the cross bar. Turn the A-Frame around, placing the poles in exactly the positions marked by the two sticks. Again mark where the string crosses the cross bar.

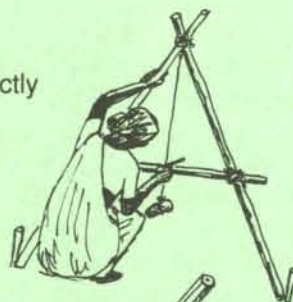

STEP 3

Mark the level mark on the cross bar – exactly half way between the previous marks. If the first two marks happen to be on the same place – this is the level mark.



STEP 4

Before using the A-Frame, collect a number of sticks. Begin, ideally with two people, at one side of the field where the first contour line is wanted. Hold one pole firmly on the ground. Move the other pole until both poles are on the ground with the string touching the level mark. Place a stick into the soil by each pole. Move the A-Frame along, by turning it around (pivoting), keeping pole 1 in exactly the same place. Move pole 2 until the string touches the level mark and place another stick into the ground by pole 2. Carry on in this way, pivoting the A-Frame across the field.

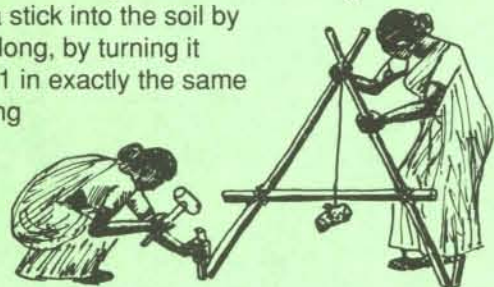

Marking the line

Whatever method has been used, the end result will be a line marked across the land with a series of sticks. If there are sharp bends in the line, then move a stick a little to make a smoother line. Such sharp bends are usually due to rocks or small holes which have affected one measurement. The contour line is now ready for whatever control measures are planned.

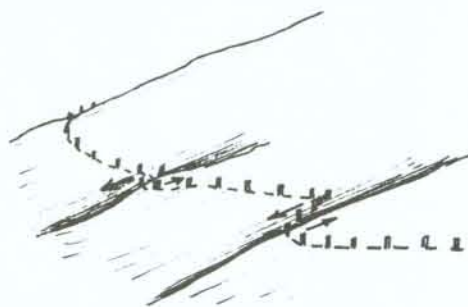

Contour Lines

THESE ARE IMAGINARY LINES across a slope which are the same height at all places along the slope. Water cannot flow along a contour line – it is completely level. Most soil erosion control methods are built along the contour lines to have maximum effect.

The Hose Level

MATERIALS NEEDED

- Two poles about 2 metres long
- Length of clear plastic tubing 10–25 metres long and about 1 cm in diameter
- Small amount of string or adhesive tape

STEP 1

Tie the ends of the tubing securely to the two poles in several places. Carefully fill the tubing with clean water, making sure no air bubbles are trapped inside, until nearly full. Hold the poles side by side, with their lower ends resting on the ground, until the water level settles at exactly the same level on each pole (ideally where it is easy to see without bending). Mark this level clearly on each pole.



STEP 2

When moving the poles, either use a thumb or fit some kind of plastic stopper to stop water spilling – these should be removed before measuring. Begin at one side of the field. One person stands still while the other moves their pole until the level mark is reached in both poles. As with the A-Frame, use marker sticks and move alternate poles so that any slight faults with the Hose Level do not affect the contour line.

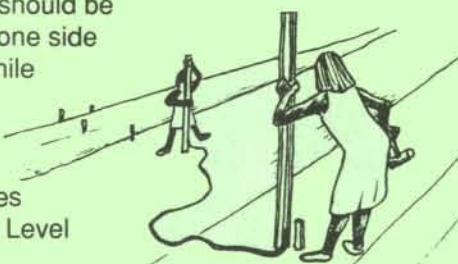

Where should the next line be?

The steeper the slope, the more contour barriers are needed to prevent erosion. Here is a very simple method for deciding where to mark the next contour line. Stand straight with one arm outstretched level in front. Walk backwards down the slope, looking at your outstretched hand, until the previous contour can be seen at the end of your hand. Make the next barrier where you are now standing.

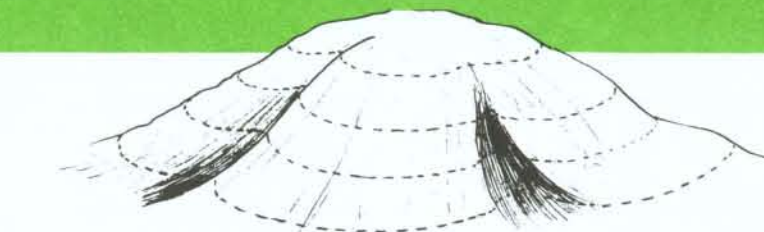

Compiled by Isabel Carter

Three methods

Contour lines cannot be guessed – they need to be measured. How can contour lines be measured without expensive surveying equipment? Here are three tried and tested methods. The first – the A-Frame – can be made at no cost, from material readily available to every farmer, and used by one or two people. The other two methods – the

Spirit Level and the Hose Level – need materials which cost a small amount of money and either two or three people – but they are quicker to use.

A WORD OF WARNING In areas which have very heavy storms it may be dangerous to prevent the water completely from flowing down a slope. Build waterways or drains at a slight angle ($\frac{1}{2}^{\circ}$ – 1°) so that excess water is safely channelled away.

The Spirit Level

MATERIALS NEEDED

- Spirit level with hooks
- 10 metres of string
- Two poles about 2 metres high



Illustration: Tom Hirst

STEP 1

Tie each end of the string firmly at the same height near the top of the poles. Attach the spirit level in the centre of the string.

STEP 2

Three people are needed – two to hold each pole firmly and keep the string tight, and a third to check the reading on the spirit level. When the spirit level is horizontal, the bubble will be seen exactly in the middle of the level. Once the level is found, place marker sticks and move across the field in exactly the same way as with the A-Frame.

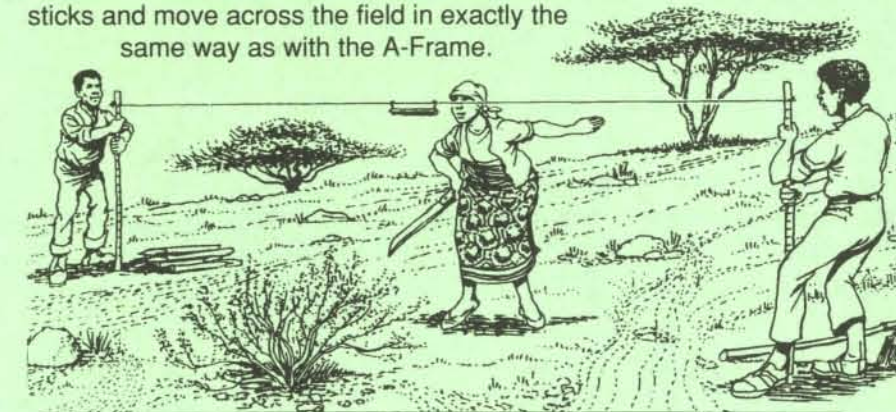
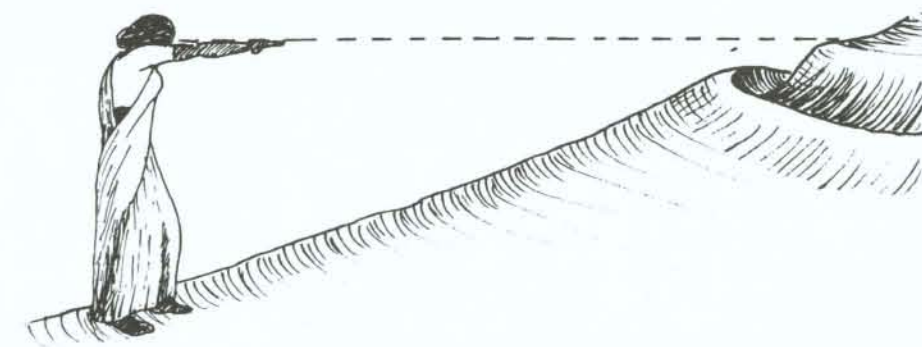

Illustration: Tom Hirst



Immunization competition!

We in EPI, Geneva would like to congratulate you on Issue 14 on immunization. We found the material interesting, well prepared, accurate and a pleasure to read. We hope it gets the wide readership it deserves.

We have a suggestion for a small competition for your readers. At the top of page 3 in *Footsteps 14* is a child health card filled in for a child named Nyakayinda Yopa. Can any of your readers spot the missed opportunity for immunization?

We will be happy to send the winner a full set of *Immunization in Practice* booklets (in English).

James Cheyne,
EPI, WHO
Geneva, Switzerland

Editor...

If any readers think they know the correct answer, please send it to me. If there is more than one correct reply, the winner's name will be chosen at random on 1st September 1993. Please do not write in after this date. Only the winner will be informed.

Hairy, fidgety Cuban sheep

CONGRATULATIONS to *Paso a Paso* for its practical recommendations. The community where I live is called 'Paz y Esperanza' and we are all farmers and children of God.

I was very interested in the article about small livestock breeding and the benefits this brings to those who carry out this activity in these difficult times. We left our home in Ayacucho (where there are many terrorists) and have lived in the jungle area of Peru since 1984. We breed Cuban sheep with hair not wool. Their pasturing is difficult because you need to look after them all day and they are very fidgety. The alternative of a corral is suggested in *Paso a Paso*. In this way people could be free on study days and Sundays. The family gardens would also produce better!

Silas S Leiva
Paz y Esperanza
San Martin, Peru

The Fast Detection Method

I WOULD LIKE TO SAY that *Footsteps* is of great benefit to my friends and myself. Here is a simple idea some

farmers in my area have developed that we would like to share with others round the world. Do you have our problem of sometimes not knowing where your chickens, ducks or guinea fowl are laying?

Keep the bird confined for a few hours and then put some pepper on the vent. Let it go immediately. It will start running to the place where it is laying. You can use this method for all kinds of birds. We call it the 'fast detection method'!

Raphael Y Ali
Catholic Agricultural Officer
PO Box 1, Tuna, Ghana

"Jesus, Master Carpenter of Nazareth, you have, through wood and nails, worked out man's full salvation. Use well your tools in this your workshop, that we who come to you in our rough state, may be changed to a truer beauty by your hand. Amen"

This beautiful prayer is above the entrance to the training workshops at CITC (Christian Industrial Training Centre), Pumwani, Nairobi, Kenya.

MISSION SUPPLIES LIMITED

MISSION SUPPLIES is a company staffed by committed Christians, seeking to help Christian workers overseas obtain equipment cheaply and quickly. We are non-profit-making and can supply a huge range of over 50,000 items at cost prices.

Solar panels are one of the many items we supply. Research is continuing in this exciting technology, bringing new possibilities and lower prices.

Dr Graham Fry of Mulongo, Zaire – one of our earliest customers – writes...

In 1985, we had a very sick young girl in our ward of 70 patients. Light was provided by one small, flickering lamp, and in this poor light, despite her grandmother sitting beside her, sadly no-one was aware of the girl's death for over an hour. Following this episode I vowed that we should try and supply solar power to the hospital as funds allowed. The first six small portable units were an absolute miracle of technology in supplying power for the dark recesses of our hospital. They've worked exceptionally well ever since. Since that time, we've been able to order large panels for elsewhere in the hospital and, recently, a solar microscope. I have no hesitation in recommending the use of solar power in isolated hospitals where it is essential to provide light for adequate nursing care. Certainly the use of these units in Mulongo has made a tremendous improvement in the quality of life for the people.

The use of solar energy brings many applications which are helpful to individuals overseas in situations where there is either no power supply or supplies are erratic. We supply all kinds of solar units:

- small battery chargers
- solar radios
- various sizes of lanterns (fluorescent and dome)
- solar heating panels
- solar pumps
- solar fridges

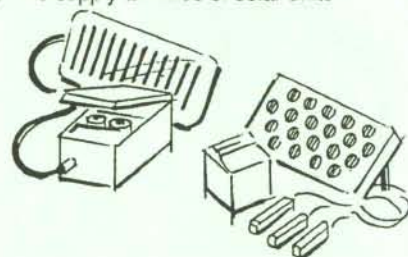

Though many are expensive initially, most will be in use for many, many years with no running costs. We are often asked whether computers can be run from solar energy. Because of their high energy consumption, they cannot be run directly from a solar panel, but they can be run from a 12 volt battery which is charged from a solar panel.

For further details of solar units or any other item, please write to:

Mission Supplies
Alpha Place, Garth Road
Morden, Surrey
SM4 4LX
UK

Fax: 081-337 7220.



Community Based Health Care

WHO IS IN CONTROL?

by Keith Wright

THE IDEA of having community based activities has become very fashionable in development work and especially in primary health care. The term *community based* was originally used to try to describe health development work that happens in a community far away from a health unit. Up to that time the services of a clinic or a mobile clinic were the closest way in which health care came to the homes of people. The clinics were organised by the health service and carried out their programmes according to their own agenda. This system did not have the opportunity to deal directly with the root causes of the majority of the health problems seen at these clinics. As a result, there was little reduction in the queues.

The idea of working directly in and with communities, quickly gained interest with donors and health personnel. It was seen as a natural development to increase the prevention side of primary health care. However, with the widespread use of the term *community based* have come many definitions of this term.

Commonly there are two types of community based health care programme. They share the same name but they work in very different ways.

Community Located

The health staff work in the community, but follow the plans and procedures of the programme which have been pre-determined in the Project office, far away from the

community. The community members are expected to participate with the plans of the programme. The important decisions are all made outside the community in the Project office. This type of community based programme can be called *community located*.

Many health care programmes are *community located* in their method of working. This is especially true for programmes which have considerable financial backing from outside agencies. This backing may come with many 'targets' and inputs that require tight pre-planning that greatly restrict flexibility. For example...

- The project insists on continuing with its plans to encourage people to build latrines, when the people's major problem is the broken bridge.
- The project plans to train 200 CHWs in a year, but less than 50 volunteer. To reach this target, the project offers attractive incentives to encourage people to volunteer.

Community Controlled

The health programme does not come with strict pre-determined plans but has the flexibility to respond to the needs of the community. These needs are identified and described by the community members – not by outsiders. Now the programme is participating with the community. The role of the programme is to strengthen the capacity of the community to control and run its own community based health care programme. This approach can be called *community controlled*.

The CBHC Programme has decided that this is how it should be organised.



COMMUNITY LOCATED

or

We have protected our springs and that was successful. So now what should we do next? When we have decided, we can tell the CBHC Programme about our plans.



COMMUNITY CONTROLLED

HEALTH

Community controlled health care programmes have the advantage of developing preventive work that is...

- supported by the community with outside services offering their services in partnership
- working on problems identified by that community
- part of on-going action within the community to carry out development work which attacks the root causes of ill health.

Support that makes a real difference

Everyone working in community based health care is genuinely concerned to 'improve' health and to maintain those improvements. To enable this to happen, the communities will need:

- the skills and encouragement to take control
- the skills to prevent preventable problems

■ the skills to carry out local development activities. They will not be able to do this alone. They will need the inputs and encouragement of outside groups.

Programmes can offer the following in a genuine co-operative partnership:

- help in identifying the problems
- encouragement that change is possible
- leadership training
- skills training
- support for plans made by the community
- skills in managing and organising community work
- planning policies that help all the above to happen.

This is not so difficult. What it requires from the programme staff and outside agencies is the courage to trust and the belief that what we cannot do alone, we can do together.

Keith Wright worked in Uganda for eight years with CBHC, training community development staff and decision makers. He now works as the Training Advisor for ITDG, Myson House, Railway Terrace, Rugby, CV21 3HT, UK.

This article was based on part of the Facilitators Manual for the Training of Trainers series. This excellent resource is made up of 4 books – a total of 500 pages – covering a whole range of subjects for the teaching of trainers – the central people in CBHC development. Much of the material is specifically designed for use in workshops – with aims, material required, case studies, discussion questions and conclusions. Though Ugandan based, the series would be readily adaptable to other countries. All contents have been thoroughly tried and tested over twelve years of workshops in Uganda, and are highly recommended.

The four volumes, with a pack of visual aids, cost US \$40 plus postage, from the Uganda CBHC Association, PO Box 325, Entebbe, Uganda.

The CHBC Chain

How would we recognise community controlled work? The Uganda CBHC Association members have developed a chain which helps people to see clearly the many different parts which make up community controlled health care.

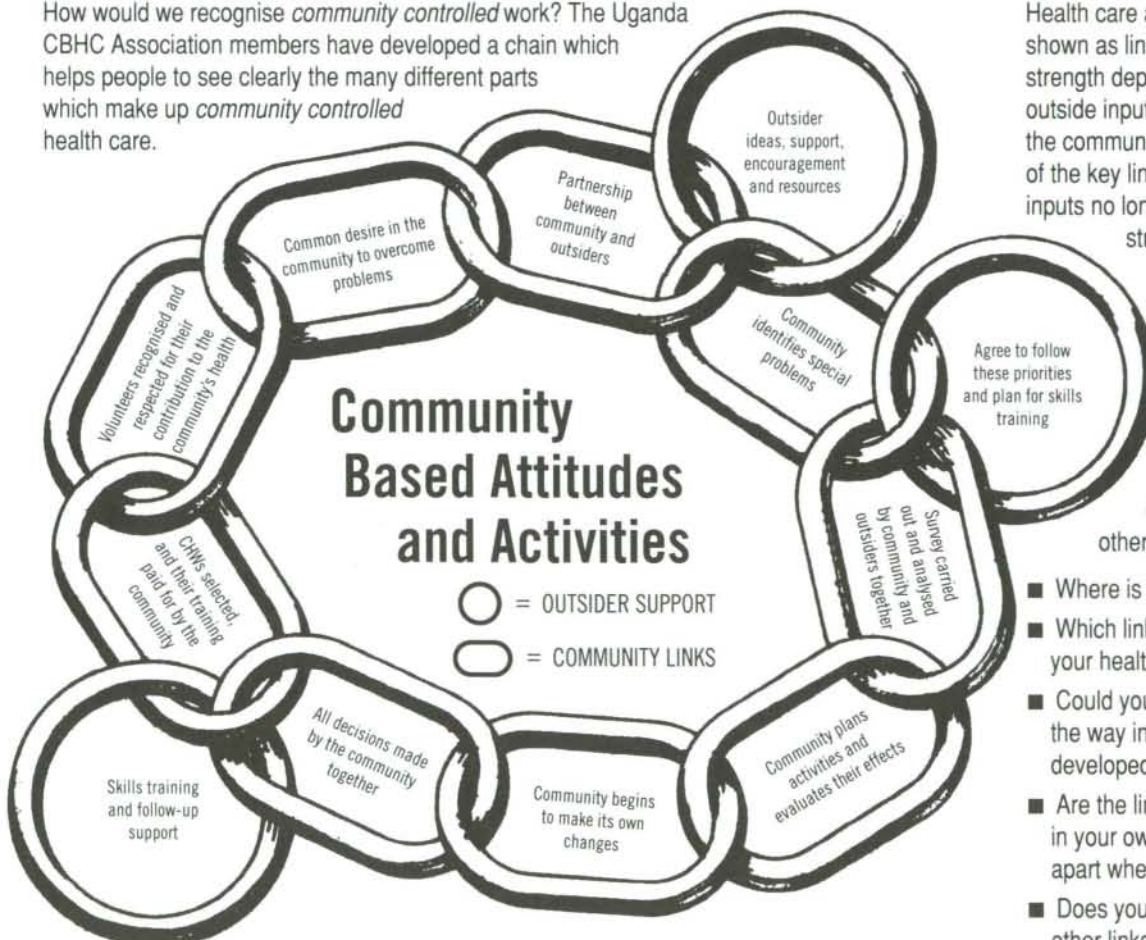

Health care activities within the community are shown as links in a chain. Like all chains, its strength depends on each link in the chain. The outside input is shown as being different from the community inputs. It does not make up any of the key links in the chain, and when outside inputs no longer operate, the chain can remain strong.

You may like to encourage a discussion of this chain with your health workers. It may bring out some helpful points about the way in which your health care programme operates. Here are some questions to encourage discussion – you may think of others...

- Where is the starting point in this process?
- Which links of this chain are very weak in your health programme?
- Could you draw up a similar chain describing the way in which your health programme has developed?
- Are the links with outside support too strong in your own programme? Will the chain fall apart when this is withdrawn?
- Does your own health programme include other links which are not shown here?



What led us to start CBHC work?

Community Based Health Care

Adapted from the *Facilitator's Resource Manual for the Training of Trainers* workshop series, Uganda CBHC Association, Kampala '91

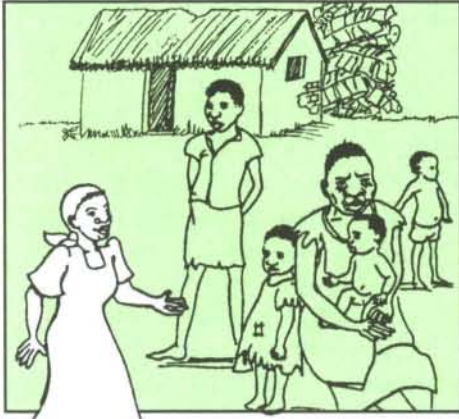

'THE MAIN ROOT CAUSES OF POOR HEALTH ARE SOCIAL AND ECONOMIC.'

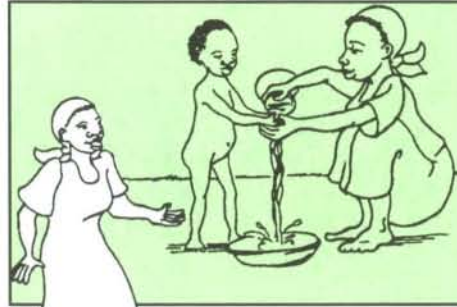

'MOST ILLNESSES (OVER 80%) ARE PREVENTABLE AT HOME OR BY THE COMMUNITY WORKING TOGETHER, OR THROUGH THE COMMUNITY HEALTH SERVICES COOPERATING TOGETHER. BUT THEY CANNOT BE PREVENTED BY THE HEALTH SERVICES ALONE.'



You must boil your water and store it in a clean pot.

'THE PHC SERVICES ARE NOT REACHING THE PEOPLE MOST IN NEED. THE CHANGES REQUESTED ARE SO DIFFERENT FROM THE NORMAL SOCIAL WAYS, THAT PEOPLE NEED TO THINK THROUGH THE IMPLICATIONS VERY CAREFULLY.'

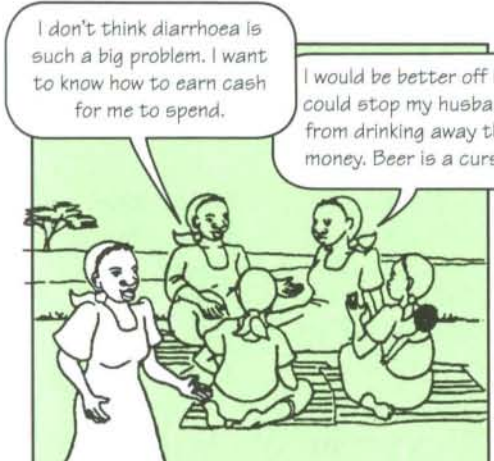

I don't think diarrhoea is such a big problem. I want to know how to earn cash for me to spend.

I would be better off if I could stop my husband from drinking away the money. Beer is a curse.

'THE SERVICES OFTEN DO NOT DEAL WITH THE REAL ROOT CAUSES TO THE PROBLEMS.'

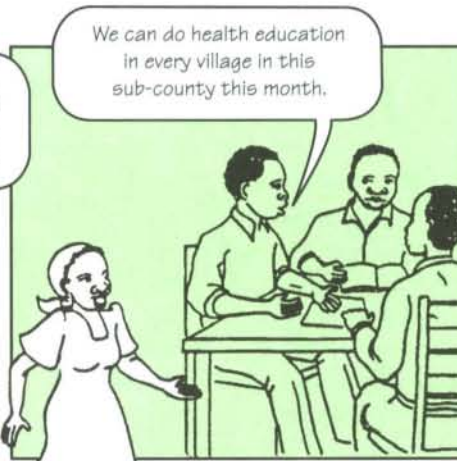

We can do health education in every village in this sub-county this month.

'THEY EXPECT CHANGES TO HAPPEN TOO QUICKLY.'



We have drunk this water the way that it is all our lives, and our fathers before us, and we survived. So I don't see any need to change.

'PEOPLE ARE SLOW TO CHANGE AND NEED A GREAT DEAL OF FOLLOW-UP SUPPORT. OUR WORK HAS TO FOCUS MORE ON CHANGE OF ATTITUDE THAN ON ANY TECHNICAL INPUTS.'



You have delivered more children than I have. What do you do when a woman starts in labour?

'PEOPLE DEMAND TO BE RESPECTED (FOR THEIR KNOWLEDGE, THEIR SKILLS, AND FOR THEMSELVES AS PEOPLE).'



Now that we have protected our spring, what is our biggest problem that we should be working on next?

'PEOPLE WANT TO MAKE THE DECISIONS THAT DIRECTLY AFFECT THEIR LIVES.'



In what ways can we show our appreciation of our health volunteers?

'SO THIS HAS LED US TO PUT THE PEOPLE FIRST IN OUR PLANNING, TRAINING AND FOLLOW-UP SUPPORT. CBHC IS THE 'PEOPLE PART' OF PHC.'

Looking After Our Land

by Will Critchley and Olivia Graham

This book and accompanying video draws together the experiences of six soil and water conservation projects in dryland regions of Kenya, Mali and Burkina Faso. The projects are very different – some government, some non-government – with different approaches to similar problems. As a result, the general principles that are drawn from the six case studies could be very helpful to groups planning similar work.

Part One draws together these principles. (Some of this information is included in our opening article.) Part Two discusses each of the six case studies in turn. Part Three provides technical information on the methods used to conserve soil and water at the six projects.

Though the book and video focus on dryland Africa, the principles will apply in other areas.

Both book and video are helpful, well illustrated resources. They are available in French and English. The book costs £8.70 and the video £16.25 including postage. Order from:
Oxfam Publications, PO Box 120,
OX2 7DZ, UK.

In Africa these are available at much reduced prices.

Contact:
ALIN
Casier
Postal 3
Dakar Fann
Senegal
for details
of local
stockists.

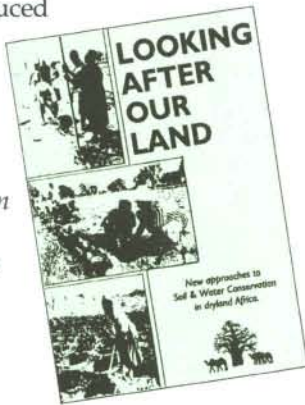

Clip Art for Development

Illustrations attract interest and help you communicate more effectively. But it can be difficult to find good illustrations dealing with agriculture and development. This collection of over 150 pages of copyright free drawings may help you solve this problem. The drawings illustrate people (mainly Asian), farming practices, livestock and crops.

This is a very helpful resource which is available at cost price. The material is available as loose pages designed to

be placed in a clip folder, so that further pages can be added.

The cost, including surface postage is \$16.00 (\$23.00 for airmail postage).

Order from:

Professor Eric Abbot
Dept of Journalism and Communication
Iowa State University
Ames
IA 50011
USA.

Cheques should be payable to
Dept of
Journalism ISU.



TALC Library Package

A new scheme to provide small libraries with vital medical and health books is being offered by TALC. There is an urgent need for many hospitals and clinics to have an up-to-date range of medical books. Sometimes it is difficult to know which books would be most appropriate.

Because of this, TALC is making two libraries available which have been selected by experts to provide the best range of information possible.

The first library is designed for district hospitals, containing 17 books ranging from two on primary surgery, an AIDS handbook, eye diseases, various books on mother and child health, dentistry, immunisation and TB. It costs £85.00 including surface mail.

The second library contains 14 books and is aimed at health workers. It includes *Where There is no Doctor*, *Immunization in Practice*, *Obstetric Emergencies* and various others on nutrition, AIDS, mother and child care and health workers. This costs £60 including postage.

There is some overlap between the two libraries so both should not be ordered together. The prices represent a reduction in the normal cost of the books and free postage. For more detailed information on these libraries or to order, write to:

TALC
PO Box 49
St Albans
Herts
AL1 4AX
UK.

Practical Guide to Dryland Farming – Books I, II, III & IV

This series was designed in Indonesia. The booklets are written in simple English with numerous excellent illustrations. They are aimed at farmers and extension agents. There are four booklets in this series...

I Introduction to Soil and Water Conservation (44 pages)

The basic principles of soil and water conservation, and a variety of contour-based systems to reduce erosion.

II Contour Farming with Living Barriers (40 pages)

Considers the reasons for contour farming with details of how to find contour lines, preparation of barriers and suitable plants to use as 'living barriers'.

III Integrated Farm Management (36 pages)

Covers a range of farming activities to increase farm productivity and reduce risk. Includes soil and water conservation, cropping methods, livestock, tree crops and care of the environment.

IV Planting Tree Crops (38 pages)

Including tree crops into farming, propagation methods, seed, stakes, grafting, air-layering, nursery care, planting out and a helpful table of useful tree species.

This is an excellent series, full of practical information. Single copies cost \$5.00 including airmail postage. The set of four booklets costs \$20.00 including surface mail (\$28.00 airmail). A free colour poster on soil fertility is included when the four booklets are ordered together. Order from:

World Neighbours
4127 NW 122 St
Oklahoma City
OK 73120
USA.

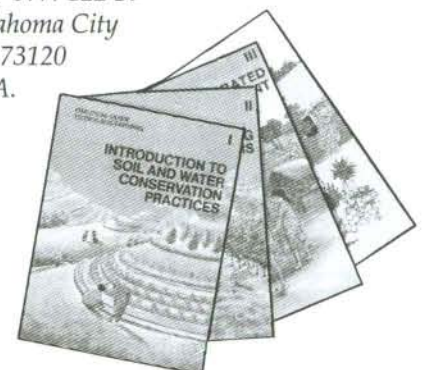

Agrodok Series

Two new booklets are now available in the useful Agrodok Series. They are:

No 7: Goat Keeping in the Tropics

Practical information on breeding, raising, nutrition, housing and diseases of goats.

No 18: Protection of Stored Grains and Pulses

Storage pests. Methods of protection against insects and moulds and the control of rats and mice.

Both booklets are available in French and English priced at Dfl 7.50.

Readers in Africa, Caribbean and Pacific can apply for these booklets free of charge from:

CTA
BP 380
6700 AJ Wageningen
The Netherlands.

VITA Booklet on Soil Erosion

VITA have produced a free booklet called *Soil Erosion and its Control*. The booklet contains a variety of ways of controlling soil erosion, to enable farmers to choose the most appropriate method for their own area. It also lists sources of information in other countries on soil erosion. Write to:

VITA
Box 12438
Arlington
Virginia 22209
USA.

Enfoque de la Evaluacion Como Proceso

(The Process of Evaluation)

This is a well illustrated and helpful booklet on evaluation. It contains information on how to approach evaluation as a process. It gives ideas

on how to decide on the content and objectives of evaluations, before designing and carrying out an evaluation. The final chapters gives information on how to handle the data collected and follow up the evaluation process.

It is available from:
Lutheran World Relief
General Silva 117 – Miraflores
Apartado 723 – Lima 100
Lima
Peru

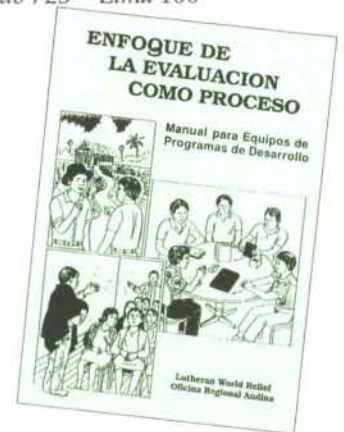

BIBLE STUDY

Our stewardship of the environment

by Suleiman Jakonda
of RURCON, Nigeria

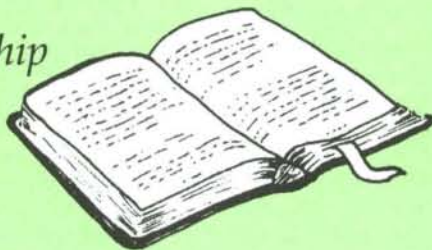

Read Genesis 1:26-31. God created all things and there was perfect harmony between all creation and God. But as we read in Genesis 3:14-19, the fall brought about sin and separation from God for both mankind and creation – breaking the perfect harmony that had existed.

However, the merciful and loving God started a process of restoration. Throughout the scriptures, the theme is that of God working through his people – priests, prophets and kings – to bring the creation back to what it ought to be. He still calls his people to be stewards of this creation.

In the Old Testament, God gave laws that will enable us to live in harmony with each other and the environment.

Read Leviticus 25:2-7 and Exodus 23:10. Discuss the significance of this law. How would it help protect the environment?

Read Leviticus 19:9-10. What would be the effects of this law? Is it practised in your community? How should this affect the profit farmers make from their land?

Read Deuteronomy 8:7-9. What was God's intention for Israel – and for us?

When we disobey God, many things (including the environment) go wrong. This is summed up by Paul in Romans 8:20-23. What do you see as the major problems facing the environment – both world-wide and in your own area? You may like to include removal of trees, pollution, the ozone layer, cash cropping, high population, soil erosion, etc.

Our response

The Bible does not speak about the present factors that have put the environment under pressure. However the Bible does give us the principles that will guide us in all we do. These principles are based on God's love. We cannot claim ignorance – 'Since the creation of the world, God's eternal power and divine nature, invisible though they are, have been understood and seen through the things he has made...' (Romans 1:20 NRS). Jesus is the ultimate demonstration of God's love to us. As Christians, we are God's stewards. As the salt and light of the world we should seek to salvage the environment. Jesus had many things to say to his disciples, but left them unsaid because the 'Spirit of truth will give guidance...' into all the truth. That spirit is guiding us today to do something about the damage to our environment.

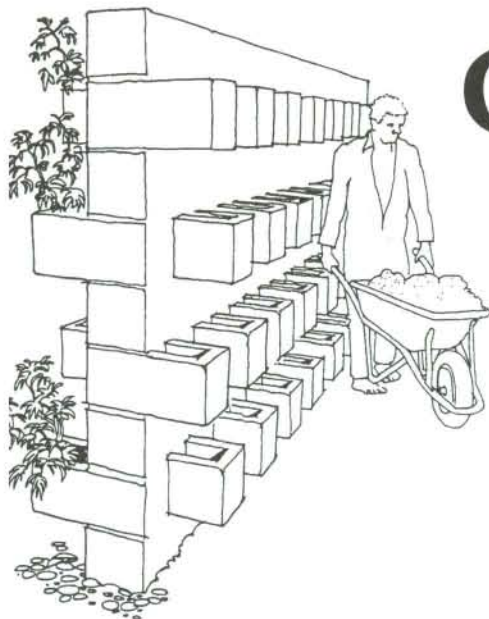

Growing Walls

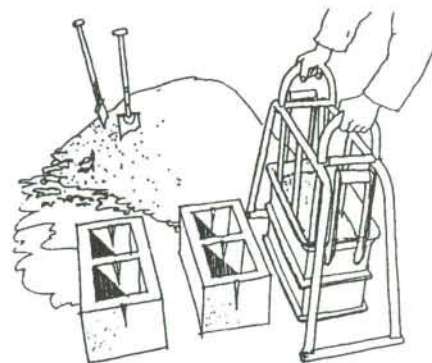

When building the wall, some of the blocks are turned sideways. The hollow part which is exposed, is given a floor and a hole for drainage. You may find it easier to add this floor and

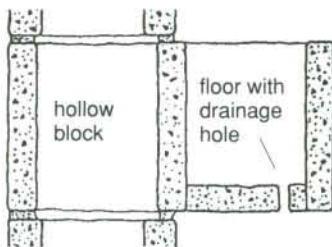

THIS IS AN INTERESTING and very practical idea developed by Gösta Nilsson, the Director of Sanitas in Botswana. He has developed a container gardening system based on walls with built-in growing boxes, made of hollow concrete blocks. The blocks are made using a simple, hand-operated block-making machine. With such a machine, two persons can make 100 blocks a day from a mix of 1 part cement and 4 parts sand. This is the size block which is used at Sanitas, but blocks of similar size would be fine...

drainage hole when casting the block. (Some block makers produce blocks with slightly tapering sides and a thin base.) The core of the wall is filled with a very weak concrete mixture (for example 6–10 parts sand or gravel to 1 part cement). The exposed containers are filled with sand on top of a thick layer of manure. The containers are then ready for planting.

The containers can be arranged in various patterns and the wall can be

A variation on the basic wall...

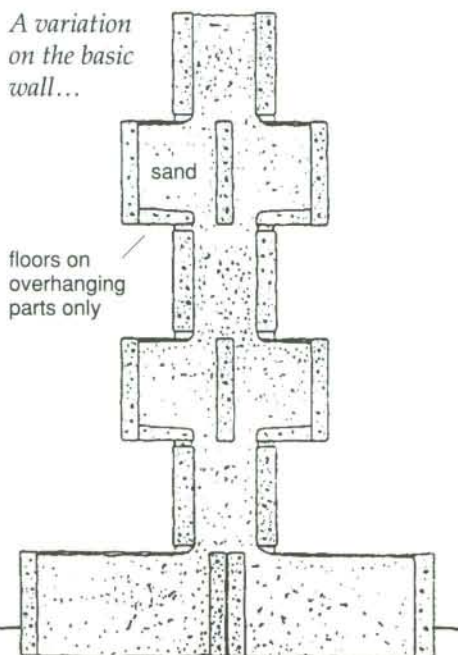

provided with containers on one or both sides. Experiment with small blocks of wood to work out a suitable design. In one interesting variation, just a quarter of the container block is projecting on each side of the wall. These overhanging blocks require floors (but no drainage holes) as shown in the diagram at the foot of the page. The whole wall is then filled with growing medium (sand and manure). This means the roots have access to a larger area as they can grow into the unturned row of blocks as well. Water can trickle down inside the wall from top to bottom.

Watering can be done either by hand or by laying a hosepipe with small holes made about every 20 centimetres along the top layer of the wall, and connecting to a tap (drip irrigation). Regular watering is essential, as walls will dry out more quickly than garden soil.

These growing walls would be ideal around compounds, or along the edges of balconies in cities. In dry areas, it might even be possible to use this idea for the building of outer walls of houses or workshops (care would be needed to prevent damp inside the building). They would make it possible to grow vegetables in a very small space.

With many thanks to Gösta Nilsson of SANITAS (PO Box 606, Gaborone, Botswana) and SIDA for permission to include this article. (A report The Productive Homestead is available free of charge from: L Akesson, SIDA, 10525 Stockholm, Sweden.)

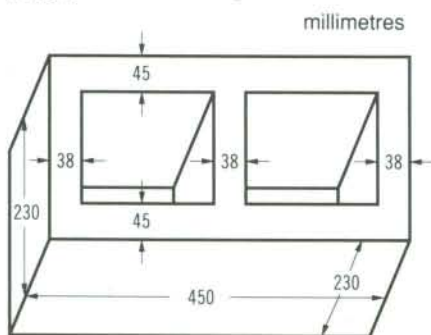

Details of how to make a simple block-making machine and lists of manufacturers are available from...

BASIN GATE

c/o Mrs H Schreckenbach, Section 402, Postfach 5180, D-6236 Eschborn 1, Germany

or from...

Otto Ruskulis, ITDG, Myson House, Railway Terrace, Rugby, CV21 3HT, UK.

Published by

TEAR FUND



CHRISTIAN CONCERN IN A WORLD OF NEED

100 Church Road, Teddington TW11 8QE, UK
Editor: Isabel Carter 83 Market Place, South Cave, Brough, N Humberside, HU15 2AS, UK